

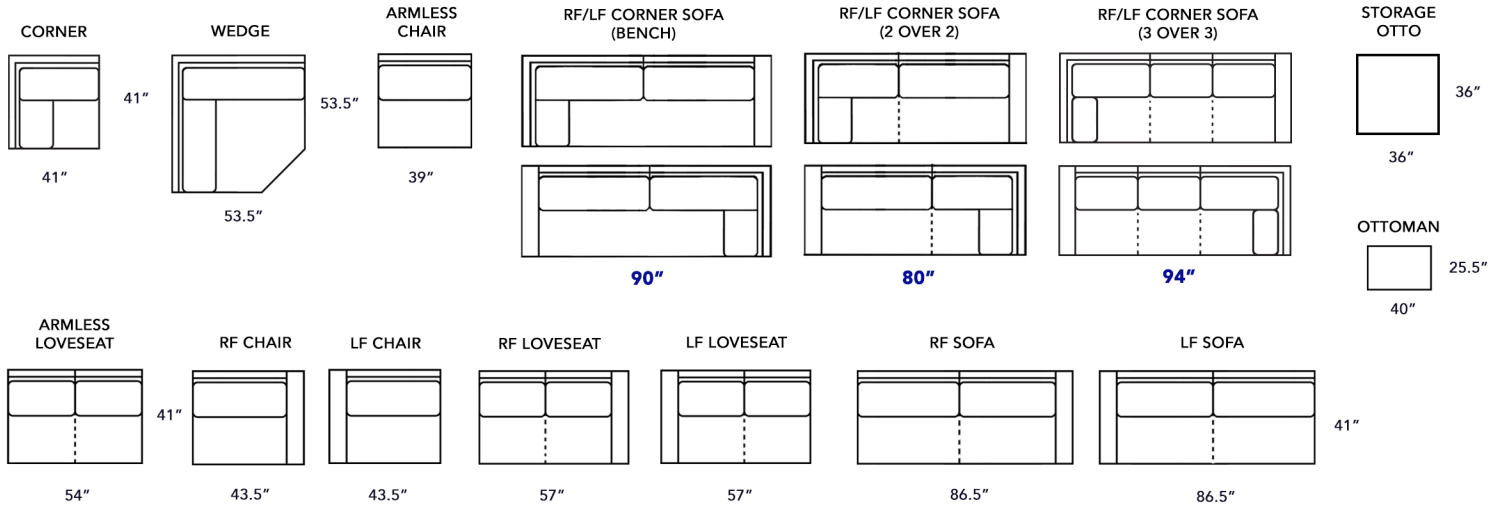

NOTE: ALL LINE DRAWINGS SHOWN WITH BENCH SEATS AND THIN ARMS. DOTTED LINE SHOWS CUSHION SEPERATION ON 2 AND 3 CUSHION OPTION, AND SEAM FOR "U" & "UM" FABRICS ON BENCH SEAT OPTION.

INDIVIDUAL PIECES



SECTIONAL COMBINATIONS

*CORNER SOFA WIDTHS VARY BASED ON CUSHION OPTION TO ALLOW CUSHIONS TO LINE UP IN THE CORNER.

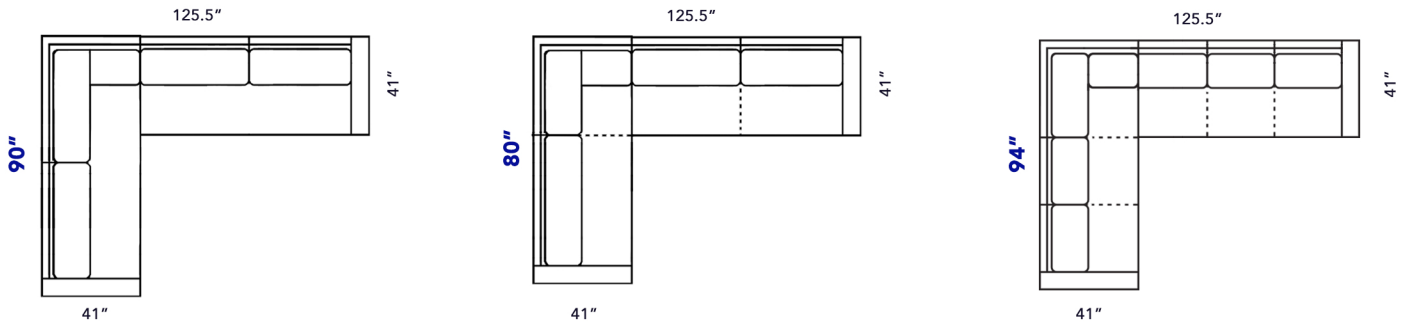

BENCH w/ THIN ARM

A 75 LF CORNER SOFA + 14 RF SOFA
90" x 125.5" x 41"

2 OVER 2 w/ THIN ARM

B 75 LF CORNER SOFA + 14 RF SOFA
80" x 125.5" x 41"

3 OVER 3 w/ THIN ARM

C 75 LF CORNER SOFA + 14 RF SOFA
94" x 125.5" x 41"

STYLE INFORMATION



55 SERIES

BACKS: LOOSE PILLOW BACKS
SEATING: SINUOUS SPRINGS
LEG USED: #67 (HIDDEN ON STYLE)
PILLOWS USED:
EXTRA LARGE - 2350-W (22")
MEDIUM - 2150-W (20")
NAILHEAD OPTIONAL, 4 FINISHES AVAILABLE
AVAILABLE IN FABRIC AND LEATHER
AVAILABLE IN ALL FABRICS

PIECE	#	OVERALL WIDTH				OVERALL DEPTH	INSIDE WIDTH	INSIDE DEPTH	ARM HEIGHT	SEAT HEIGHT
		THIN	TRACK	ROLL	WEDGE					
SOFA	10	36	89	91	93	41	78.5	24	26	20
LOVESEAT	30	36	61	62	64	41	61	24	26	20
CHAIR	40	36	48	50	52	41	39	24	26	20
OTTOMAN	50	16	40				25.5			
RF SOFA	14	36	86.5	87.5	88.5	89	41	82.5	24	26
LF SOFA	15	36	86.5	87.5	88.5	89	41	82.5	24	26
XA LOVESEAT	31	36	54	54	54	41	55	24	26	20
RF LOVESEAT	34	36	57	58	59	60	41	55	24	26
LF LOVESEAT	35	36	57	58	59	60	41	55	24	26
XA CHAIR	41	36	39	39	39	41	39	24	26	20
RF CHAIR	44	36	43.5	44.5	45.5	46	41	39	24	26
LF CHAIR	45	36	43.5	44.5	45.5	46	41	39	24	26
STORAGE OTTO	55	19.5	36							
CORNER	70	36	41	41	41	41	41	24	24	20
WEDGE	71	36	53.5	53.5	53.5	53.5	38.5	38.5		20
C. SOFA BENCH	74/75	36	90	92	94	95	41	80	24	26
C. SOFA 2 OVER 2	74/75	36	80	82	84	85	41	71.5	24	26
C. SOFA 3 OVER 3	74/75	36	94	96	98	99	41	85.5	24	26

PILLOWS BY PIECE

SOFA	2 XP, 2 MP
LOVESEAT	2 XP, 2 MP
CHAIR	2 XP
OTTOMAN	-
RF/LF SOFA	1 XP, 1 MP
XA LOVESEAT	-
RF/LF LOVESEAT	1 XP, 1 MP
XA CHAIR	-
RF/LF CHAIR	1 XP, 1 MP
STORAGE OTTO	-
CORNER	2 XP, 1 MP
WEDGE	2 XP, 1 MP
RF/LF C. SOFA	3 XP, 2 MP
RF/LF C. SOFA	3 XP, 2 MP
RF/LF C. SOFA	3 XP, 2 MP

*MEASUREMENTS ARE BASED ON A 5555 THIN ARM. OVERALL WIDTH WILL CHANGE BY ARM AND SEAT TYPE. PER ARM: +1" FOR TRACK, +2" FOR ROLL, +2.5" FOR WEDGE.



Build your own



5548L SOFA



5556L SOFA



5567L SOFA

BUILD YOUR STYLE IN 3 STEPS

it's easy!

example:



4
5
6

SEAT
OPTION

- 3 CUSHION
- 2 CUSHION
- BENCH

ARM
OPTION

5
6
7
8

- THIN
- TRACK
- ROLL
- WEDGE

▲ SHOWN ABOVE

= **5567** SOFA

STEP ONE: CHOOSE A SEAT

1

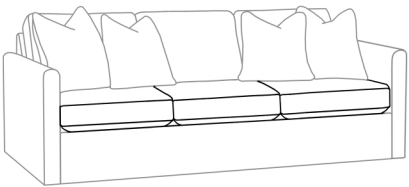

3 CUSHION 554x

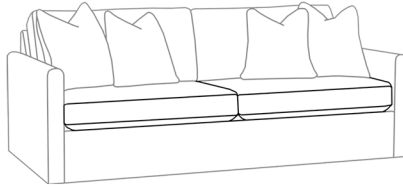

2 CUSHION 555x

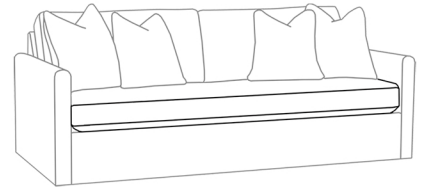

BENCH 556x

STEP TWO: CHOOSE AN ARM

2



THIN 55x5

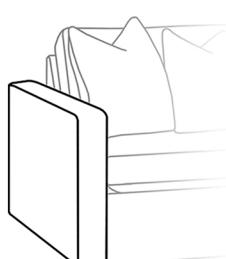

TRACK 55x6

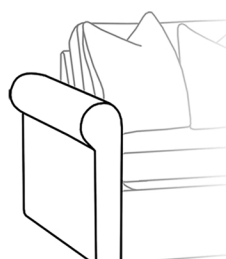

ROLL 55x7

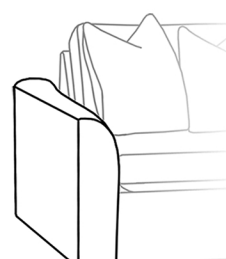

WEDGE 55x8

STEP THREE: CONFIGURE LIKE ANY OTHER MAYO PIECE

3

- Choose body fabric or leather.
- Choose optional 22" pillows, welt or fringe, fiber or down.
- Choose optional 20" pillows, welt or fringe, fiber or down.
- Choose optional decorative nails.

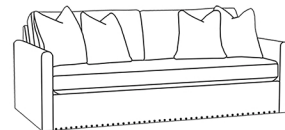

SEE REVERSE SIDE FOR SECTIONAL INFORMATION. SEE CATALOG FOR DETAILED SPECIAL ORDER INSTRUCTIONS.